

User Manual

Digibar[®] II

PE350

Contents	Page
Safety instructions	4
1 List of components supplied	8
2 Fitting	8
3 Connections	12
3.1 Operation with lithium battery (3.6V)	13
3.2 Operation with two miniature cells	15
3.3 Operation with external supply voltage	16
3.4 Operation with relay board	17
3.5 Relay contacts circuit logic	18
4 Commissioning	19
5 Multi-function display	20
5.1 Trend indicator	20
5.2 Digital measured value display	20
5.3 Bar graph	21
5.4 Menu block	21
5.5 Text box (units/function field)	21
5.6 Symbol bar	22
5.6.1 Battery symbol	22
5.6.2 Input lock	22
5.6.3 Limit value/hysteresis warning	22
5.6.4 Analogue output warning	22
5.6.5 MIN/MAX	22
6 Button functions	23
6.1 Operating	24
6.2 Overview of operating functions	25
6.3 Functions	25
6.3.1 OPERATION group	25
6.3.2 CONFIG group (Limit value 1, lower limit value)	26
6.3.3 SERVICE group	29
6.3.4 SPECIAL group	30
6.4 Typical settings	35
7 Overview of operating functions	39
8 Technical Data	41
9 Dimensions	44
10 Adjustment ranges and factory settings for PE350	45
11 Options for PE350	49
12 Certificate of Conformance	51

Safety instructions

Use in accordance with the regulations

The PE350 digital differential pressure gauge is to be used exclusively for pressure measurement tasks and directly related control tasks. Use for any additional purpose shall be deemed to be not in accordance with the regulations.

To ensure safe operation the differential pressure gauge must be used only in accordance with the information in the User Manual. It is also essential to observe the appropriate legal and safety regulations for the application concerned during use. The same applies to the use of accessories.

The differential pressure gauge is not a safety device even when used in accordance with the regulations. Perfectly safe operation of the differential pressure gauge requires proper transport, technically correct storage, installation and assembly as well as careful operation and maintenance.

General dangers of failing to follow the safety instructions

The PE350 digital differential pressure gauge is a state-of-the-art device and is safe to operate. The differential pressure gauge may give rise to further dangers if it is inappropriately installed and operated by untrained personnel.

Any person instructed to carry out installation, commissioning, maintenance or repair of the differential pressure gauge must have read and understood the User Manual and in particular the technical safety instructions.

Remaining dangers

The scope of supply and list of components supplied with the differential pressure gauge cover only part of the scope of measurement technology. In addition, equipment planners, installers and operators should plan, implement and respond to the safety engineering considerations of measurement technology in such a way as to minimise remaining dangers. Existing regulations on the subject must be observed. Reference must be made to remaining dangers connected with measurement technology.

If there is any risk of remaining dangers when working with the PE350, it is pointed out in this introduction by means of the following symbols:

Symbol:  **DANGER**

Meaning: Maximum danger level

Warns of a **decidedly** dangerous situation in which failure to comply with safety requirements can lead to **death or serious physical injury**.

Symbol:  **WARNING**

Meaning: **Possibly dangerous situation**

Warns of a **potentially** dangerous situation in which failure to comply with safety requirements can lead to **death or serious physical injury**.

Symbol:  **CAUTION**

Meaning: **Dangerous situation**

Warns of a possibly dangerous situation in which failure to comply with safety requirements can cause damage to property or lead to some form of **physical injury**.

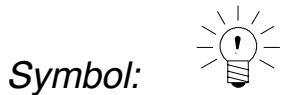

Note

Means that important information about the product or its handling is being given.

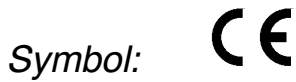

Meaning: CE mark

The CE mark enables the manufacturer to guarantee that the product complies with the requirements of the relevant EC guidelines (see Certificate of Conformance at the end of this User Manual).

Working safely

Modifications to settings in *Digibar II* – particularly if protected by passwords – and assembly and service work may be carried out only by trained and authorised personnel.

Error messages must not be ignored. The reason for the error must be removed before further use.

Conversions and modifications

The differential pressure gauge must not be modified from the design or safety engineering point of view except with our express agreement. Any modification shall exclude all liability on our part for any damage resulting therefrom.

In particular, any repairs, soldering work on motherboards or replacement of components is prohibited. Repairs may be carried out only by HBM.

Qualified personnel

This instrument is only to be installed and used by qualified personnel strictly in accordance with the technical data and with the safety rules and regulations which follow. It is also essential to observe the appropriate legal and safety regulations for the application concerned during use. The same applies to the use of accessories.

Qualified personnel means persons entrusted with the installation, assembly, commissioning and operation of the product who possess the appropriate qualifications for their function.

Accident prevention

Even though the specified pressure in the destructive range is a multiple of the final value of the measuring range, the relevant accident prevention regulations of the trade safety associations must be taken into consideration. Thus, for example, a burst protector is to be provided on the transducer where conditions cannot be perfectly defined.

1 List of components supplied

PE350 differential pressure gauge, user manual; shortened user manual (Digibar II operating functions) enclosed with the device.

Accessories (included in the components supplied):

Skintop PG16 screwed cable connector, with seal, battery contact springs, sealing rings (USIT rings 22.7 x 30 x 2 and 8.5 x 13.4 x 1; for 1-PE350A1...)

Accessories (to order):

Lithium battery 3.6V 13.5Ah	Order No. 3-3319.0009
Plug-in power pack	Order No. 3-3318.0002
Power pack for support rail mounting	Order No. 1-NT101A, (230V, 50...60Hz /15V=650mA)
Bracket for support rail mounting	Order No. 2-9289.1713

2 Fitting

The PE350 can be built in like a mechanical manometer.



DANGER

Before installing/dismantling the differential pressure gauge ensure that the circuit is pressure-free!

- Fit threaded connector G1 1/2" with enclosed seal (48 x 55 x 2). More possible threaded connectors: G1/2 form B or M20 x 1.5 with USIT ring 22.7 x 30 x 2 or 8.5 x 15.4 x 1, also NPT 1/4 -18.

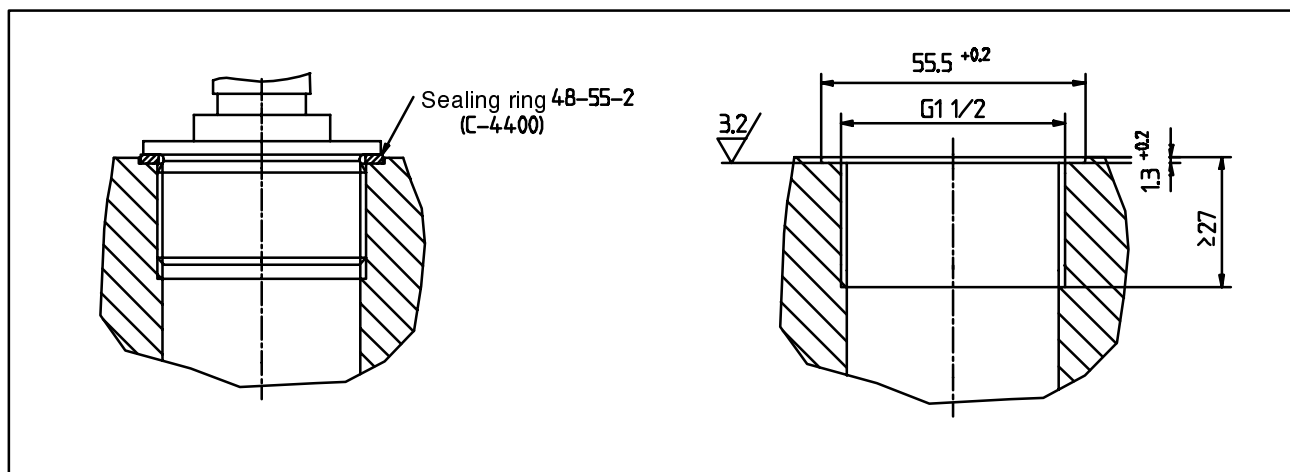

Fig. 2.1: Pressure connector sealing (G1/2 form B, USIT ring 22.7x30x2)

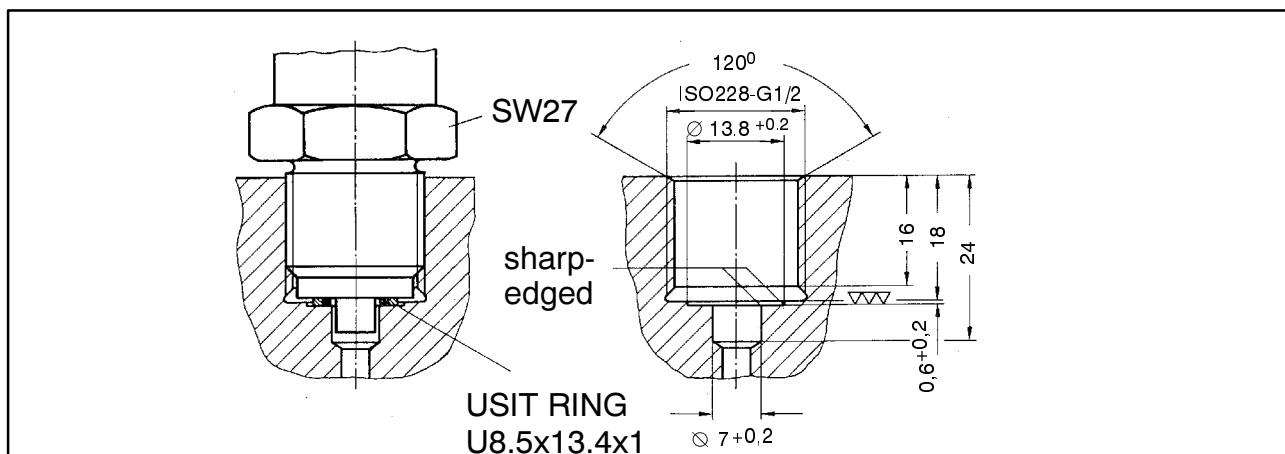

Fig. 2.2: Pressure connector sealing (G1/2 form B, USIT ring 8.5x13.4x1)

- The PE350 on the SW27 hexagon above the threaded connector should be screwed into a prepared connection piece.



CAUTION

When screwing the PE350 into a connection piece, exert the turning force on the SW27 hexagon, not on the housing.

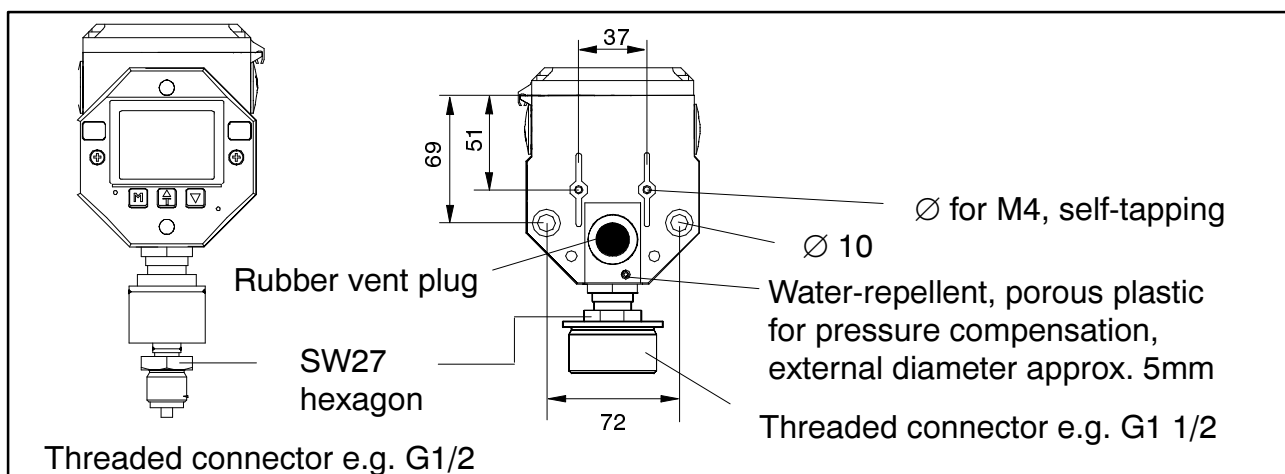

Fig. 2.3: Screwing in a PE350 on a SW27 or SW32 hexagon

The PE350 is designed and built in accordance with the standard for safety manometers (DIN 16006).



The **rubber vent plug** relieves pressure within the housing if the measuring element bursts.

The **small plastic tube** for pressure compensation on the differential pressure gauge element can be extended with a flexible pipe to keep aggressive ambient air away from the measuring element of the PE350. The filter plug prevents fluids from entering the hole (Protection System IP65).

Direction of pressure connector (orientation of display)

If installation conditions make it necessary to modify the display position (e.g. if there are many bends in the pipes or in the event of overhead installation), the front part of the housing with the display can be rotated in 90° steps.

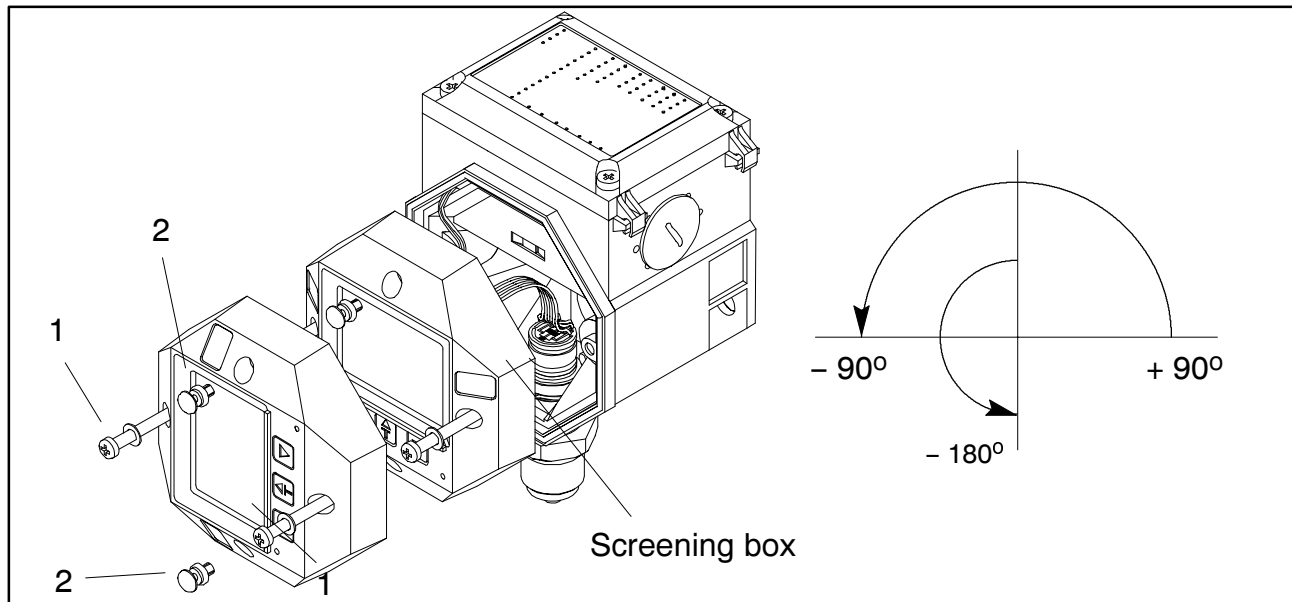

Fig. 2.4: Rotating the front part of the housing

1. Remove screws (1)
In the case of mounting in the $\pm 90^\circ$ position, interchange the screws (1) and vent plug (2). Withdraw the vent plug outward towards the front.
2. Rotate the cover with the display into the required position and tighten both screws again.



CAUTION

Do not touch the printed circuit board, since electrostatic charges could destroy the electronics.



NOTE

Take care not to trap or jam any cables.

The sensor cable must stay within the screening box. The power cable is fed through the gap between the plastic housing and the screening box.

Alternative fitting suggestions

If the PE350 is mounted on pressure circuits that are unable to support the device, the housing is provided with integral fastening points that suit the purpose.

- Support rail

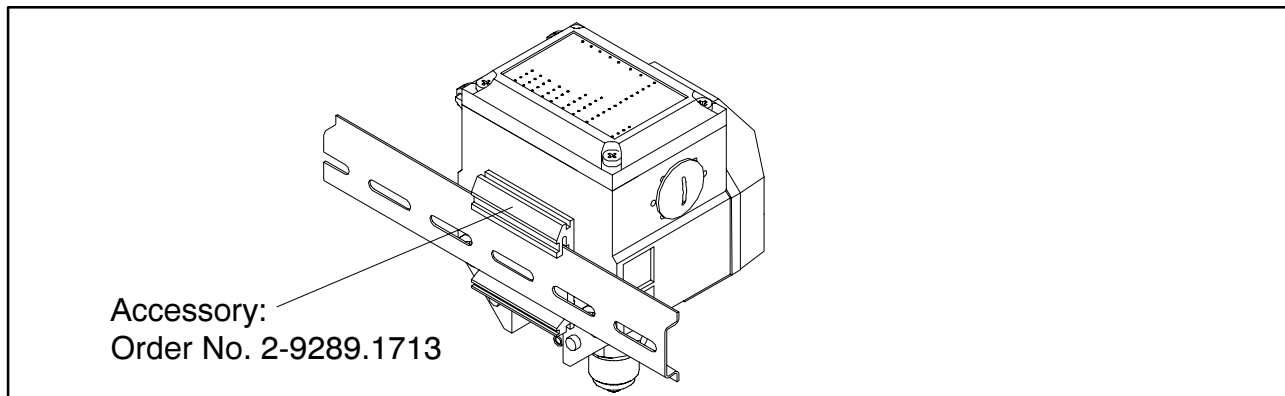

Fig. 2.5: Mounting on support rail

- C support rail

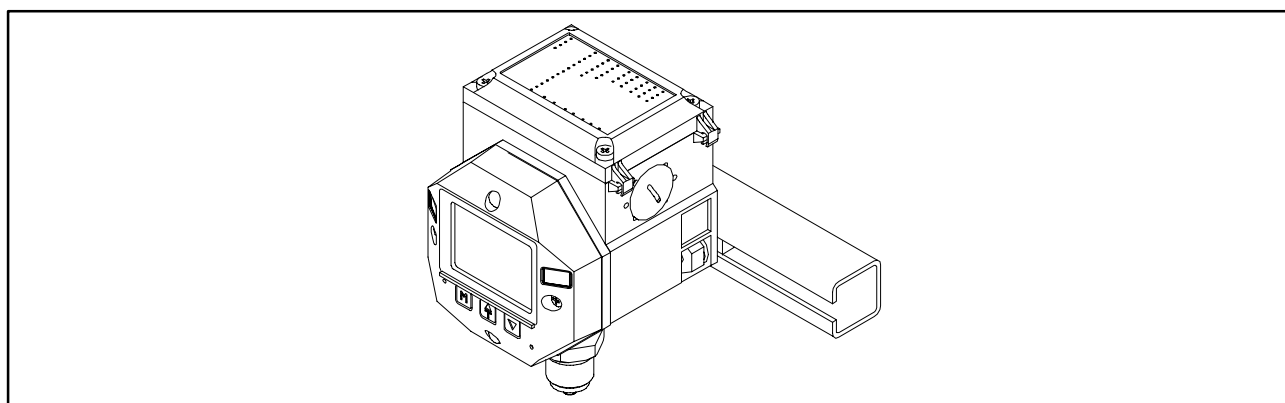

Fig. 2.6: Mounting on C support rail

– Pipe circuit

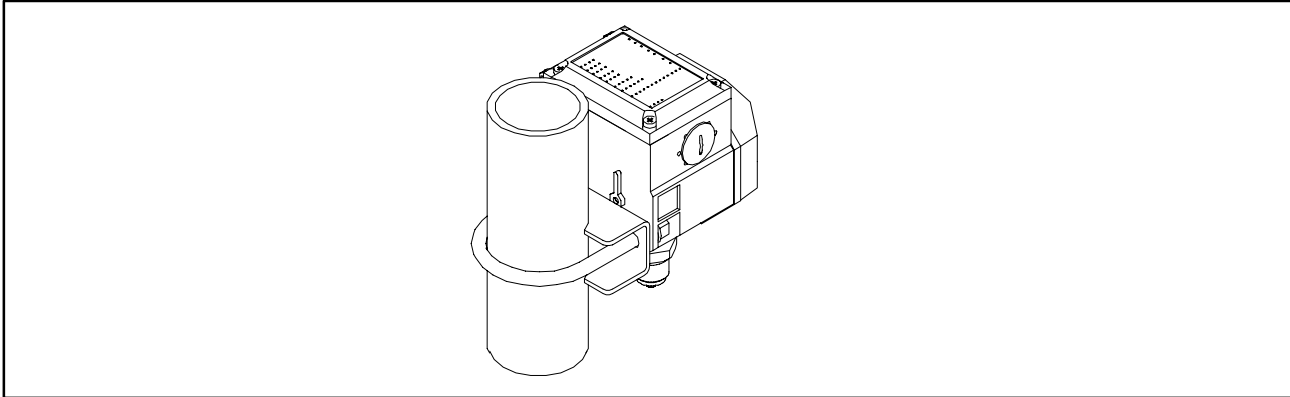

Fig. 2.7: Mounting on pipe circuit

The support rails and fittings for mounting on pipe circuits are not included in the HBM delivery schedule.

3 Connections

You can operate the PE350 in two different modes:

1. As a digital manometer: power supply using a lithium battery (3.6V). There is also an option to operate the PE350 with two miniature cells (1.5V each).
or
2. As a pressure measurement transmitter: operation with external supply voltage and current output.

In both cases the PE350 selects its own operating mode, depending on the voltage applied:

	Supply voltage	Operating mode	Measuring rate
Battery operation	2,6 ... 3,8V	without current output	1/sec
External power supply	9 ... 30V	with current output	4/sec



CAUTION

The PE350 differential pressure gauge corresponds to Device Protection Class III and must be supplied with an extra-low safe voltage.

Voltage values exceeding 30V will destroy the device!
Never insert batteries when the device is being supplied with an external voltage.

3.1 Operation with lithium battery (3.6V)

Inserting the lithium battery:

1. Open the housing cover: Loosen the fastening screws until they are level with the surface of the cover. Lift the cover.
2. Slide the battery contact springs into the slots provided. The ends that have been formed into cable eyes should then be inserted under the connecting terminals (see Fig. 3.1).
3. Insert the lithium battery. Please use the correct polarity!
4. Close the housing cover and tighten the screws.
5. Press  to start the PE350 operating.

Note: To switch off the PE350, use the OFF function from the OPERATION function group (see page 26).

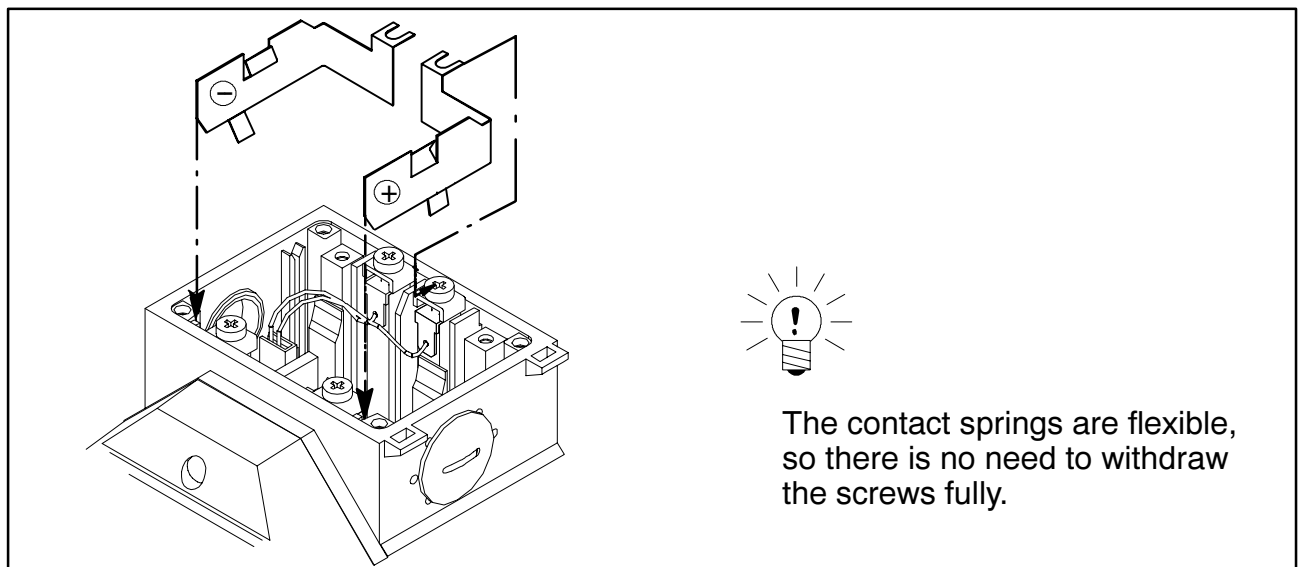

The contact springs are flexible, so there is no need to withdraw the screws fully.

Fig. 3.1 Inserting the battery contact springs

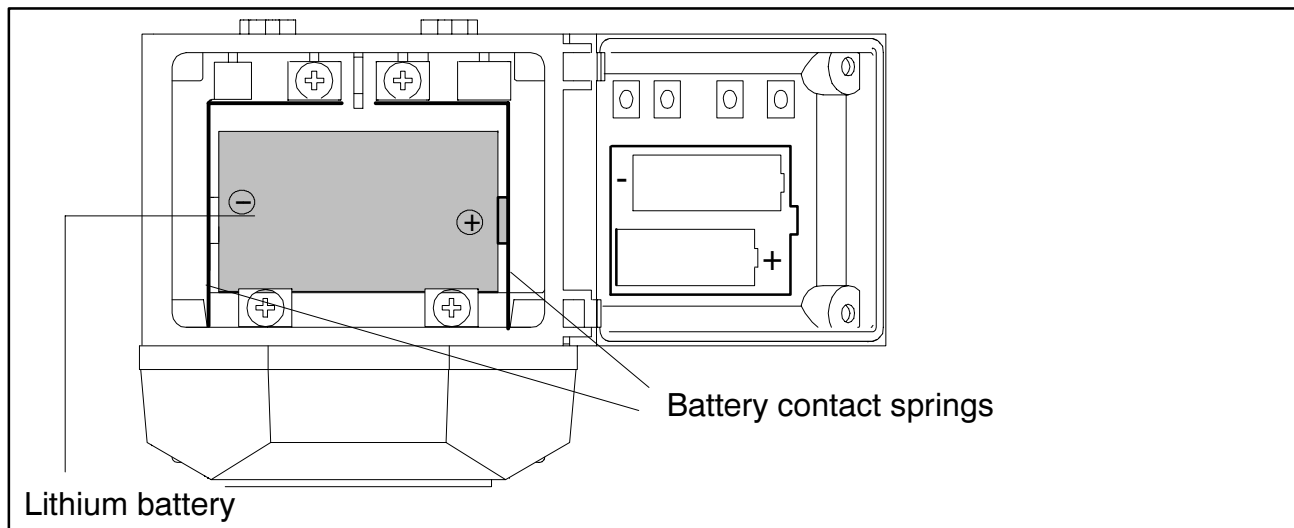

Fig. 3.2 Inserting the lithium battery

Characteristics of the lithium battery:

Rated voltage 3.6 V

Rated capacity 13.5Ah

Order no. 3-3309.0009

Once the lithium battery has been inserted the PE350 starts a display test. The instrument then switches itself off.

To switch the instrument on again: press button .

Note:

Even with a new lithium battery it is possible that the battery symbol  may take some time to go out.

3.2 Operation with two miniature cells

Inserting the miniature cells:

1. Open the housing cover
2. Fit battery contact springs
3. Insert two miniature cells (1.5V each)
4. Close the housing cover and tighten the screws.

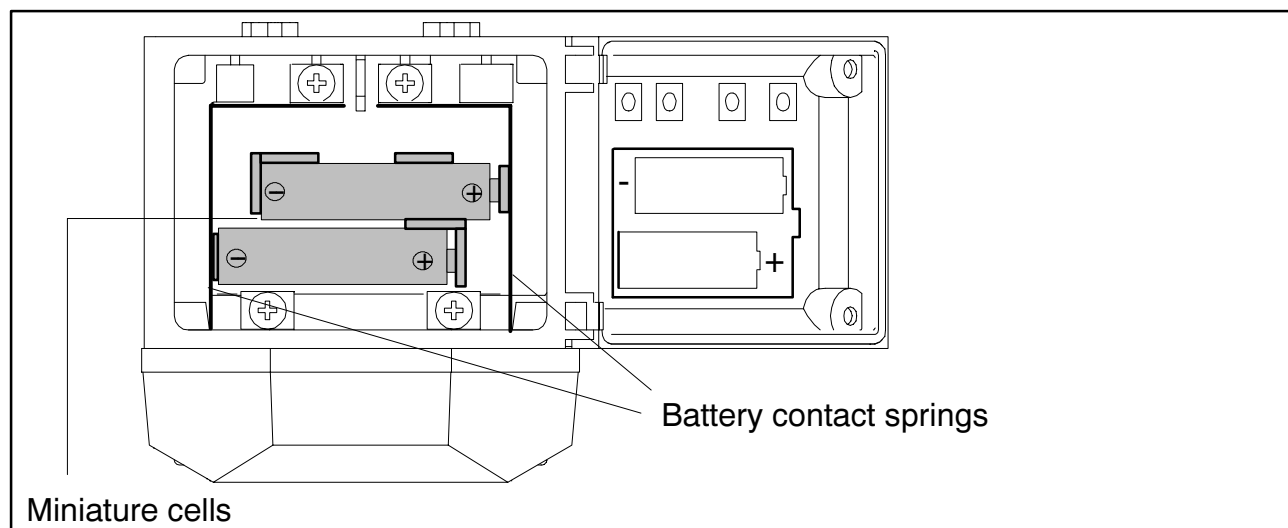



Fig. 3.3 Inserting miniature cells



NOTE

The miniature cells are not pressed down by the cover and may come loose from their mounting under unfavourable conditions. Insert a suitable piece of foam material that will press the batteries down when the cover is closed.

Due to the low supply voltage (3V) the battery symbol  is displayed even with fresh miniature cells. The PE350 will not operate with NiCd accumulators (1.2V).

Battery service life:

Power supply (V)		Service life
Lithium battery 3.6V, 13.5Ah	ON	>9 months (measuring rate 1 measurement/s)
	ECO	>18 months (measuring rate 6 measurement/s)
	OFF	5 years
Miniature cells (1.5V each)		>3 weeks (measuring rate 1 measurement/s)

3.3 Operation with external supply voltage

Connecting the external power supply:

1. Open the housing cover
2. Unscrew the PG blind screw fitting (on the left or right side)
3. Screw in the cable gland and fit the cable
4. Screw the cable ends to the appropriate terminals, **but do not insert battery contact springs**
5. Close the housing cover and tighten the screws. Ensure a close fit between the PG blind screw fitting and the cover.

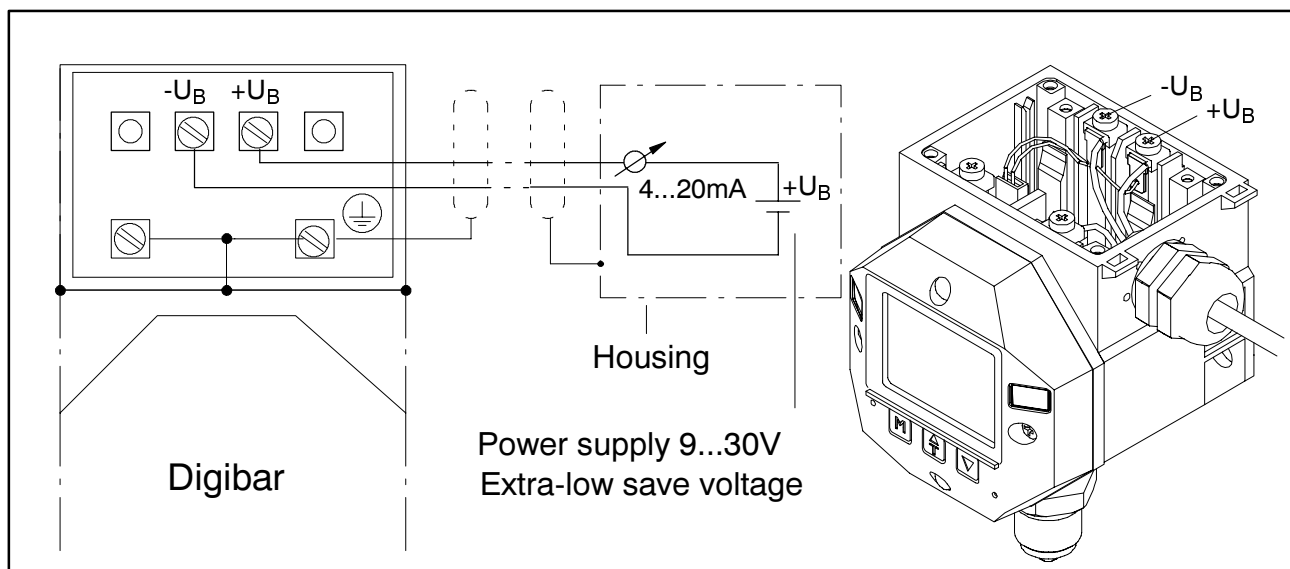

Fig. 3.4 Connection for 4-20mA output current (2 wire)

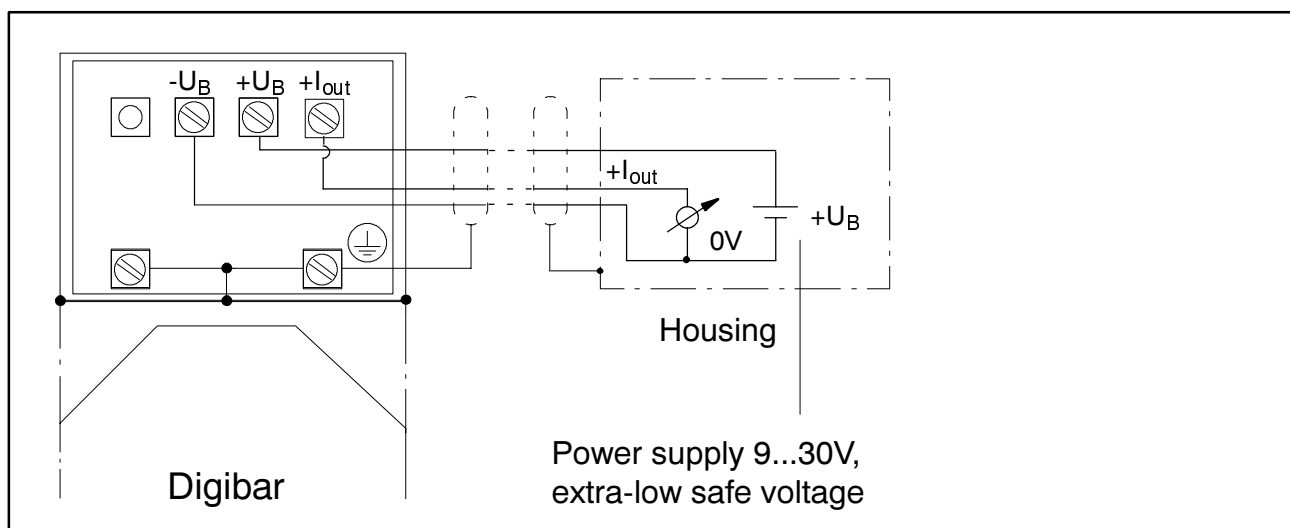

Fig. 3.5 Connection for 0-20mA output current (3 wire)

After connecting a supply voltage the PE350 starts a display test. The measured value then appears in the display.



NOTE

If the supply voltage does not rise to over 8V within approx. 2 sec, the PE350 behaves as it would under battery operation, i.e. it switches itself off.



To switch the instrument on again: press button .

If the supply voltage has risen to at least 9V in the meantime, the PE350 operates as it would under an external supply voltage (see page 16).

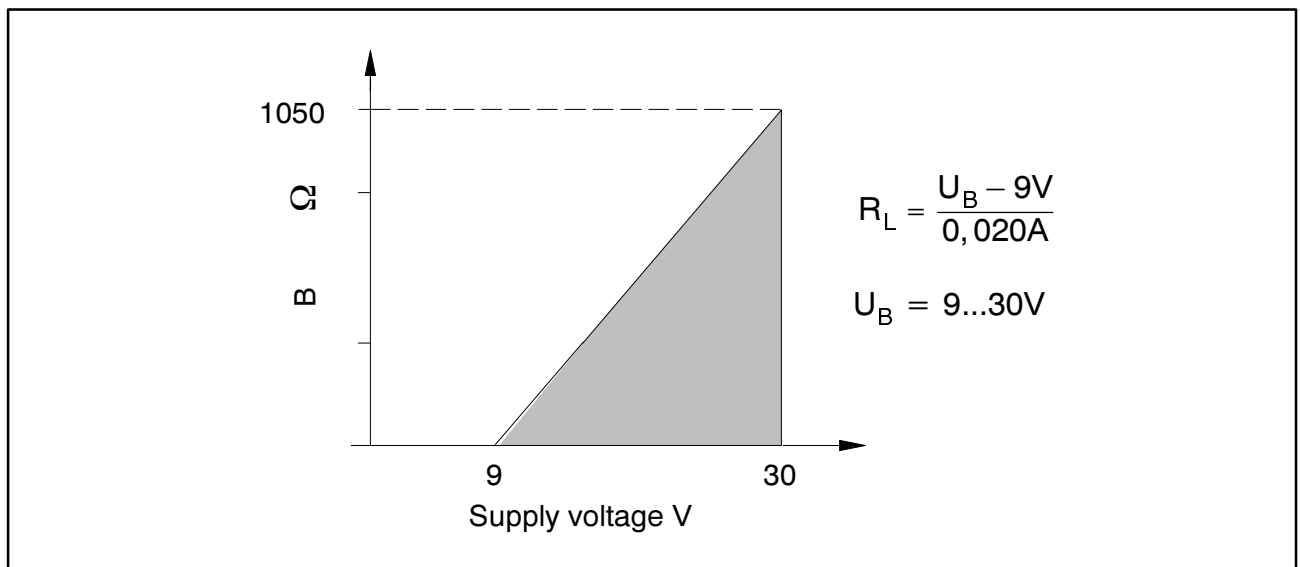

Fig. 3.6 Operating area current output

3.4 Operation with relay board

If you are operating a PE350 with a relay board (option 3, code IOR; see table on page 49), please connect it in accordance with the following connection chart. Please note that operation with a relay board is only possible in three-wire connection and with an external supply voltage (no battery operation).

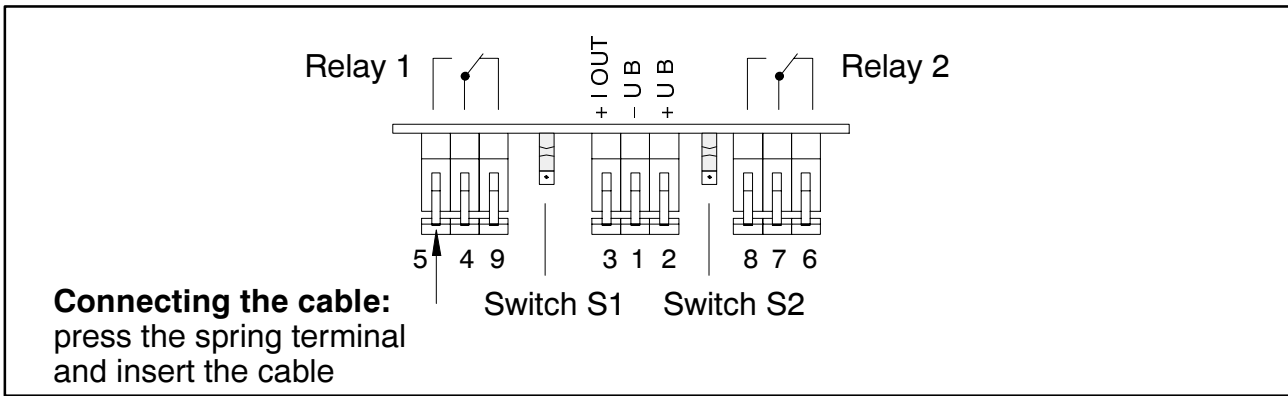

Fig. 3.7 Connecting the relay board

3.5 Relay contacts circuit logic

The switchable limit-relay circuit logic means that you can use switches S1 and S2 to set up different connection states in the relay. This allows safety power-downs to be carried out or alarm messages to be generated (for example in the event of loss of the power supply circuit).

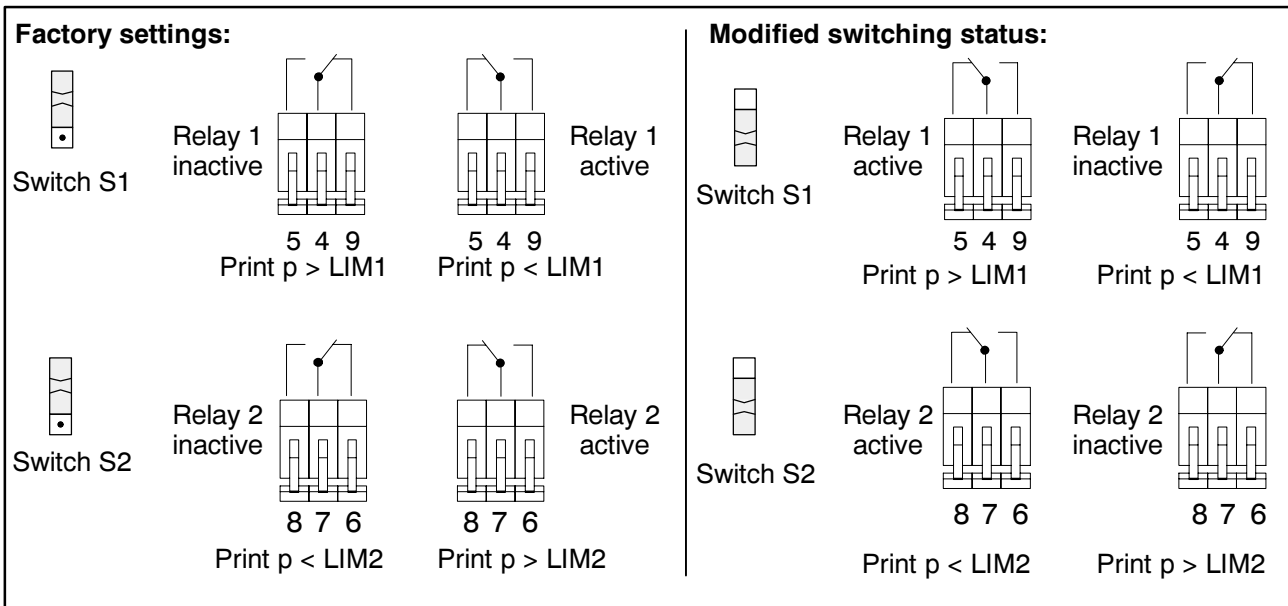

Fig. 3.8 Relay connection states

4 Commissioning

- Install the *Digibar II* as described on page 8
- Connect the *Digibar II* (see chapter 3)

Operating mode **MEASURE**:

In MEASURE operating mode (power supply >9V), measuring mode begins as soon as the external supply voltage is applied.

In measuring mode, the measured value display, bar graph and display trend arrows, as well as the Min/Max buffer, current output and limit value switches, respond to every change of pressure. Pressure values are displayed in the unit of measure Bar.

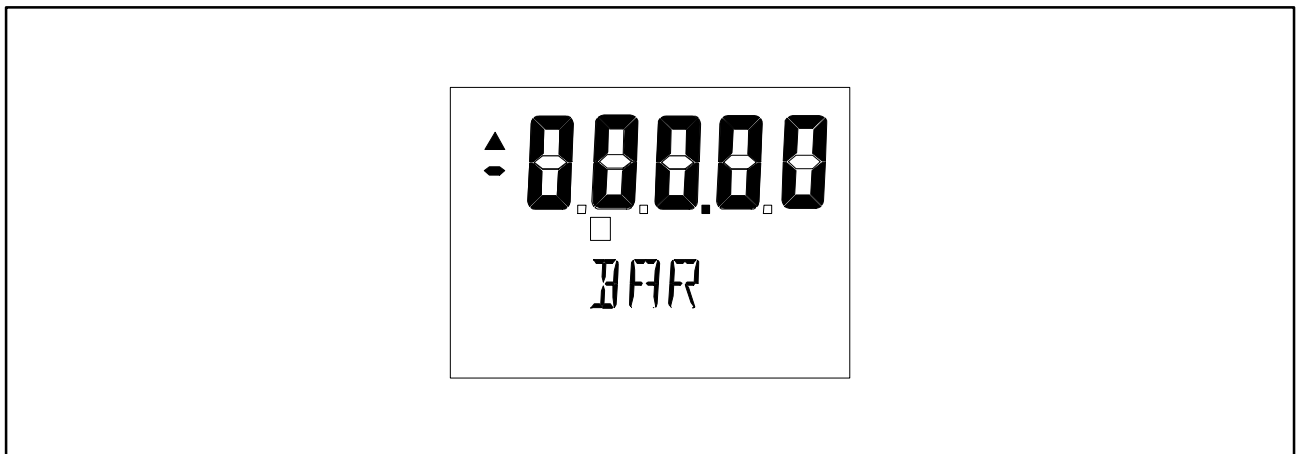

Fig. 4.1 Display on first switching on

5 Multi-function display

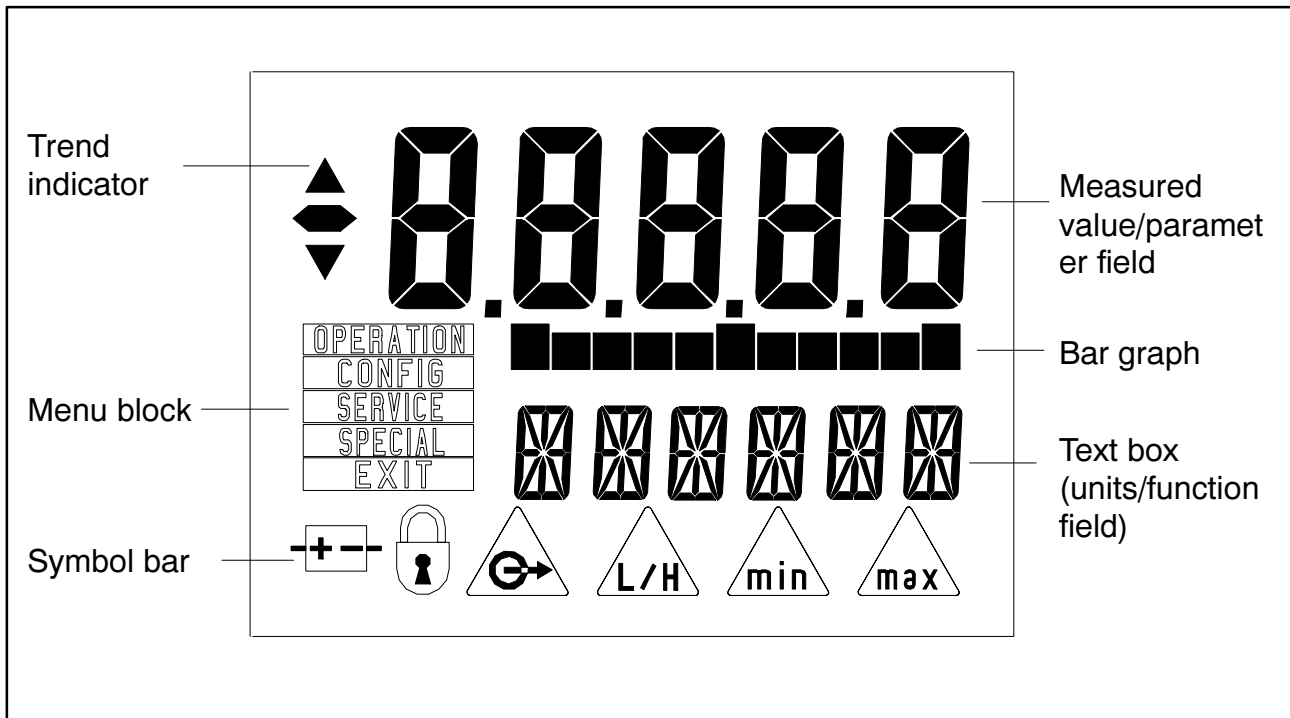

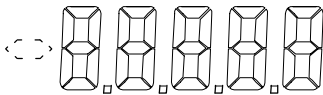

Fig. 5.1 LCD

5.1 Trend indicator

The trend arrows show rising  or falling  pressure. They change over when the pressure changes direction by at least 0.1%.

5.2 Digital measured value display



A measured value is presented in a five-digit, seven-segment display. When a value is displayed, leading zeros are not suppressed (e.g. **008.00**). Negative values are indicated by a minus sign. There are 4 possible positions for the decimal point. If the value exceeds the measuring range by more than 3% or undershoots the nominal measuring range by more than 4%, the displayed number flashes and stops changing.

5.3 Bar graph



The bar graph indicates the current pressure within both defined limit values as an analogue band (zoom function).

If the upper limit value (LV2) is exceeded, the extreme righthand segment flashes. If the lower limit value (LV1) is undershot, the extreme lefthand segment flashes.

5.4 Menu block

OPERATION
CONFIG
SERVICE
SPECIAL
EXIT

When the operator dialogue is opened, the menu block shows the currently selected function group. In measuring mode, no function groups are displayed. Further details of the various function groups start on page 25.

5.5 Text box (units/function field)

E.g.:

ON/OFF

The name of the current function (e.g. ON/OFF) is displayed during operator dialogue.

The selected physical unit of measure is displayed here in plain text during measuring mode.

5.6 Symbol bar

The symbol bar contains 6 symbols that indicate special operating states of the *Digibar II* :

5.6.1 Battery symbol



The supply voltage is below 3.2V. The lithium battery should be changed soon.

5.6.2 Input lock



The LOCK function is used to lock out inputs. You cannot change any parameters. In order to amend parameters, the lock must be removed (see page 34).

5.6.3 Limit value/hysteresis warning



The sum of the limit value and hysteresis is greater than the spread of the measuring range, i.e. the limit value or the hysteresis value of the limit value switches (option) cannot be reached.

5.6.4 Analogue output warning



The pressure values that have been assigned to the starting or final values of the output current (4mA, 20mA) are outside the measuring range. During any pressure rise within nominal measuring range, it will no longer be possible to reach the starting or final values of the output current.

5.6.5 MIN/MAX



During operator dialogue, these symbols indicate that the previous minimum value/peak value has been cleared and replaced by the current minimum value/peak value. The symbol goes out when you quit the function.

6 Button functions

The front panel includes the following buttons





The  button:

- Opens the operator dialogue
- Confirms your choice of a function group (e.g. OPERATION)
- Confirms your choice of a function (e.g. STEP)
- Confirms (saves) a setting

Functions of the buttons   :

- Selecting a function group from the menu block.
- Selecting a function from a group that has been opened.
You may select the name of the next or previous function.
- Changing a displayed setting.

Pressing the button for a moment changes the setting in steps of one numerical value at a time. Pressing the button for longer scrolls the value in steps of 10 at a time. If you hold the button down, scrolling speeds up and you can run through the entire range of settings very quickly.

If the PE350 has the SPECIAL software option, the TARE function can be switched on (TARE "ON"). The   buttons then have the following function in measuring mode:













The current display value is transferred to the tare buffer and the display is reset to zero.





The net (i.e. tared) display is replaced by the gross (i.e. untared) display. The indication GROSS is displayed in the text box. Pressing the  button again switches you back to the net display with the physical indication in the text box.

6.1 Operating

All operating procedures on the PE350 are carried out with the three control buttons. All settings and parameters are recalled or changed by functions. The procedure for choosing a function and recalling or changing settings is the same in every case:

<i>Digibar II</i>	<i>Press button</i>	<i>Reaction from the</i>
<ul style="list-style-type: none"> • Open dialogue: block 		Function group OPERATION is displayed in the menu
<ul style="list-style-type: none"> • Select function group: 	 or 	Function group is displayed in menu block (e.g.) CONFIG
<ul style="list-style-type: none"> • Open function group: 		The first function in the group is displayed in the text box (e.g.) LIM1
<ul style="list-style-type: none"> • Select preferred function: 	 or 	Chosen function is displayed in text box (e.g.) STEP
<ul style="list-style-type: none"> • Activate function: current 		Activated function STEP flashes; the step is in the measured value field
<ul style="list-style-type: none"> • Select/change value: 	 or 	Chosen step numerical (e.g. 20 digits) is displayed in measured value field
<ul style="list-style-type: none"> • Confirm 		Activated function stops flashing, pressure value is displayed in value field

The setting is confirmed. You can now use  or  to select another function, or return to measuring mode by selecting and confirming EXIT. If no button is pressed for about 30 seconds, the PE350 switches back to measuring mode. If it switches back before a new setting has been confirmed, this new setting does **not** take effect. You can use this security feature to cancel incorrect input that you have entered by mistake.

6.2 Overview of operating functions

OPERATION	CONFIG	SERVICE	SPECIAL*	EXIT
MAX	LIM 1	TEST	KEY	
MIN	LIM 2	mA OUT	UNIT	
ON/OFF	HYST 1	SWIT 1	FACTOR	
EXIT	HYST 2	SWIT 2	POINT	
	=0/4mA	EXIT	%CAL S	
	=20mA		ZERO	
	STEP		LMLIM 1	
	CAL Z		LMLIM 2	
	EXIT		TARE	
			SAVE	
			RECALL	
			CODE	
			LOCK	
			EXIT	

* only with Option 7, Code S



6.3 Functions

Descriptions of functions always use an active (i.e. flashing) function as their starting point. All descriptions explain the meaning of the setting and the range of adjustment. In all cases, exit from the function with the **M** button.

6.3.1 OPERATION group

Function MAX

The indicator displays the contents of the peak-value store. If the maximum value is exceeded, its current status is indicated at once in the display.



Pressing  or  clears the peak-value store, i.e. the current value is adopted. The symbol MAX is displayed as confirmation. Switching the PE350 off and on again clears the peak-value store.

Function MIN

Displays and clears the minimum value store. Behaves the same way as function MAX.

Function ON/OFF

This function is only needed for battery operation.

Press  or  to select operating mode ON, OFF or ECO. If operating mode OFF is chosen, the PE350 carries out a display test and switches off.

Pressing  reactivates the device.

Mode	Measuring rate	Battery service life
ON	1 measurement in 1 sec	>9 months
ECO	1 measurement in 10 sec	>18 months
OFF	-	5 years

When operating with an external supply voltage, the OFF setting causes a restart.



Function EXIT

Returns to measuring mode.

6.3.2 CONFIG group (Limit value 1, lower limit value)

Function LIM 1



The lower limit value is displayed (in the current unit). If this value is undershot, the lefthand segment of the bar graph flashes. If the PE350 is fitted with a relay board (Option 3, Order code I0R), relay LV1 switches on.

Press  or  to alter the limit value. The lowest value is -4% of nominal measuring range; the highest value must be less than the value of LIM 2.

Factory setting: 0

Function LIM 2 (Limit value 2, upper limit value)

The upper limit value is displayed (in the current unit). If this value is exceeded, the righthand segment of the bar graph flashes. If the PE350 is fitted with a relay board (Option 3, Order code I0R), relay LV2 switches on.

Press  or  to alter the limit value. The highest value is 103% of nominal measuring range; the lowest value must be greater than the value of LIM 1.

Factory setting: 100% of nominal measuring range

Note: The two limit values form the starting and end point of the bar graph indicator. The bar graph displays the range of pressures between the two limit values (zoom function, see page 21).

Function HYST 1 (Hysteresis value for limit value 1)

Value HYST 1 defines the deactivation point for relay LV1. The deactivation point for LV1 exceeds the value of LIM 1 by value HYST 1.

Range of adjustment: 0 to 107% of nominal measuring range.

Factory setting: 5% of nominal measuring range.

Note: For devices without a relay board (Option 3) this function has no effect.

Function HYST 2 (Hysteresis value for limit value 2)

Value HYST 2 defines the deactivation point for relay LV2. The deactivation point for LV2 is lower than the value of LIM 2 by value HYST 2.

Range of adjustment: 0 to 107% of nominal measuring range.

Factory setting: 5% of nominal measuring range.

Note: For devices without a relay board (Option 3) this function has no effect.

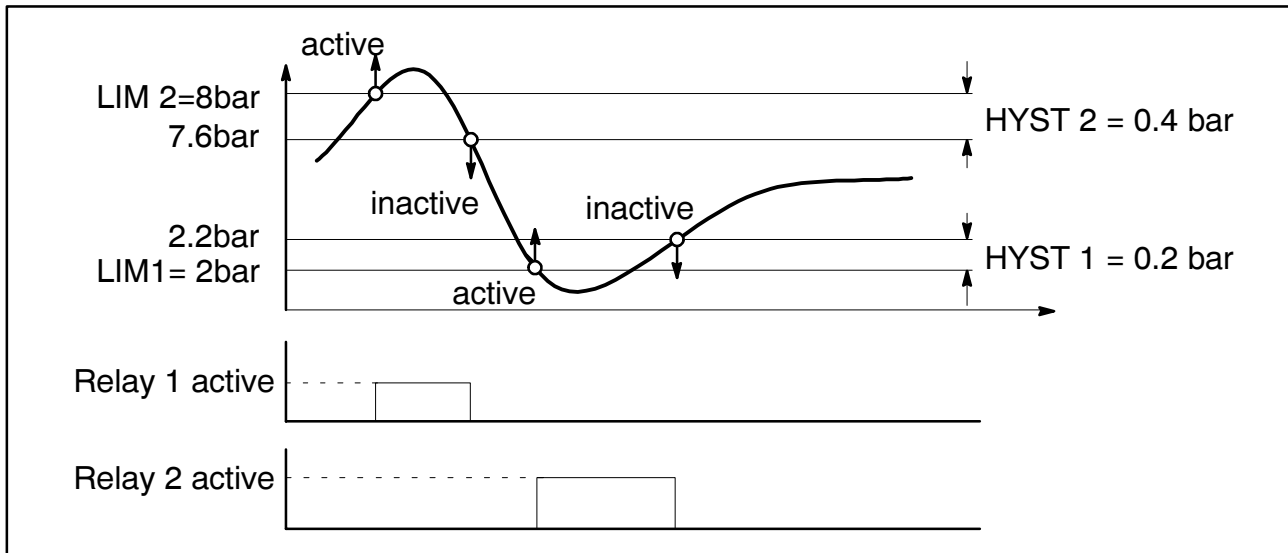

Fig. 6.1: Settings for limit values and hysteresis

Function =0/4mA

Displays the initial value corresponding to a current of 0mA or 4mA in the current unit of measure.

Factory setting: 0

Note: During battery operation this function is not available.

Function =20mA

Displays the final value corresponding to a current of 20mA in the current unit of measure.

Factory setting: 100% of nominal measuring range

Note: During battery operation this function is not available.



NOTE



The following applies to the functions =0/4mA and =20mA:

The characteristic curve for the current output can be set up as

required. The  symbol is displayed if pressure values for the starting or end point are outside the measuring range. These two values must be separated by more than 20% of nominal measuring range if the highest recommended spread of the measuring range, i.e. 1:5, is not to be exceeded (see example on page 38).

Function STEP

Displays the smallest numerical step-width of the digital indicator. Press

 or  to select steps of 1, 2, 5, 10, 20, 50, 100, 200, 500, or 1000.

Factory setting: 0.1% of nominal measuring range

Function CAL Z

For balancing the zero point. This function is only used for readjustment (for example if a non-zero value is displayed when the PE350 is free of pressure).

Range of adjustment: $\pm 5\%$ of nominal measuring range.



NOTE

Before you enter a value in CAL Z, the parameter STEP should be set at 1 so that the correction value can be read off with maximum resolution.

Function EXIT

Returns to measuring mode.

6.3.3 SERVICE group

Function TEST

 Hold this button down: an I/D number and the date of manufacture will be displayed in the text box.

Example: 01002

950504

 Hold this button down: the display test is activated. All segments light up.

Function mA OUT

The currently applicable output current in mA is displayed. The downstream measuring system will be fed with a 4mA or 20mA current (e.g. in order to test a plotter).





NOTE

Press  to close this function. To allow enough time to test the connected devices, the timeout for automatic return to measuring mode is extended from half a minute to 5 minutes.

Note: During battery operation this function is not available.

Function SWIT1/SWIT2

The status of the limit value switch is displayed (ON or OFF). For testing connected devices, use  or  to close and open the limit value switch.

Note: During battery operation this function is not available. For devices without a relay board (Option 3) this function has no effect. When the function is terminated the limit value switch returns to its original status.

Function EXIT

Returns to measuring mode.



6.3.4 SPECIAL group

The SPECIAL function group is only available on devices that were ordered with Option 7, Order code S.

Access to this function is through a confidential code number as a protection against unauthorised use.

Function KEY



This function is automatically active when the SPECIAL function group is chosen. It is the key to this function group.

Press  or  to set up the password (between 00000 and 09999) and confirm it with . An incorrect entry returns you immediately to measuring mode. If you input the correct password, you can access any function in the SPECIAL group.

Factory setting: 00001

Function UNIT

The current measured value is displayed in the unit of measure Bar. Press

 or  to select the following units:

BAR, mBAR, KPA, MPA, PSI, mH2O,

KN, N, MN, LBF, KLBF,

KG, G, T, LB, ,KLB,

Nm, KNm,

mm, μm, m, IN,

no display (- - - - -)

Pressure unit selected, e.g. mbar:

The current measured value is automatically converted and displayed in the chosen pressure unit. If the nominal measuring range is not suitable for the chosen unit, the display shows 99999 (Overflow indicator). The functions FACTOR and POINT are not displayed.

Any unit chosen (except a pressure unit)

The current measured value is **not** converted. The display shows – – – – –. If you choose such a unit of measure, the PE350 automatically switches to the FACTOR function.

Function FACTOR

This function can only be accessed from the UNIT function.

If you choose any unit (other than a pressure unit), a factor must be entered in order for the current value to be converted into the required unit.

FACTOR = Display value / final scale value.

The range of adjustment for the factor is limited so that the new final value can not exceed the maximum display range (99999).

Factor adjustment range:

Nominal measuring range	FACTOR
100mbar or 1bar	0.0909 ... 9.0908
400mbar or 4bar	0.0227 ... 2.2727

Example:

A PE350 with nominal measuring range 4Bar is to display 9.8KLB.

FACTOR = $9.8/4 = 2.45$

Due to the limits on the range of adjustment (at 4 bar, maximum 2.2727) a factor of 0.2450 is set up.

The display then shows 0.9800KLB.

The correct decimal point (2.450) will be set up in the next function POINT.

Function POINT

This function can only be accessed from the FACTOR function.

Use this function to define the decimal point.

In the above example, the decimal point must be moved one position to the right: Old: 0.0000 New: 00.000)

After confirmation and EXIT the display shows: 9.8000KLB

Function %CAL S

Adjusts the final scale value. This function is only used for readjustment. The display shows the correction value as a percentage of the range.

Range of adjustment: $\pm 5\%$ of nominal measuring range.

Factory setting: 0

Example:

Nominal measuring range:	4Bar
Display at 4Bar:	4,05Bar
Input (correction):	-1.25%



NOTE

Before you enter a value in %CAL S, the parameter STEP should be set at 1 so that the correction value can be read off with maximum resolution.

Function ZERO

The function permanently shifts the zero point on the instrument. The display and current output are reduced in accordance with the specified pressure value.

Range of adjustment: $-4\% \dots 103\%$ of nominal measuring range.



CAUTION

When zero point on the instrument has been moved, the display can show zero even though there is still pressure at the connection.

Note: Since the zero point on the instrument shifts the scale range and the characteristic curve of the current output, the limit values or end point of the characteristic curve for current may lie outside the range. The appropriate warning symbols are then activated in the display.

Function LMLIM1 / LMLIM2

The functions limit the range of adjustment of the two limit settings. The lower limit value LIM1 can only be set up between LMLIM1 and LIM2; the upper limit value LIM2 can only be between LIM1 and LMLIM2.

Range of adjustment: -4% ... 103% of nominal measuring range.

Function TARE

The status of the TARE function is displayed (ON or OFF).

If the TARE function is ON, the arrow keys have a special significance in measuring mode:

- The current display value is transferred to the tare buffer and the display is reset to zero.
- The NET display is replaced by the GROSS display. The indication GROSS is displayed in the text box. Pressing the button again switches you back to the net display with the physical indication in the text box.

Switching the PE350 off and on again resets the tare buffer to zero (taring is cleared).

Note: Since taring shifts the scale range and the characteristic curve of the current output, the limit values or end point of the characteristic curve for current may lie outside the range. The appropriate warning symbols are then activated in the display.

Factory setting: OFF

Function SAVE

With SAVE, all settings carried out in the operator dialogue can be saved **as a new basic setting**.

Save settings: Choose ON

Do **not** save settings: Choose OFF (exit function)

Factory setting: OFF

Function RECALL



Recalls the parameters stored with SAVE and restarts. If no settings of your own have been stored with SAVE, RECALL sets up the factory settings.

Recall settings: Choose ON

Quit function without changing: Choose OFF

Factory setting: OFF

Function CODE

Displays the 4-figure code number. Press  or  to change the code number. This new code number will then be used in the KEY function to access the SPECIAL group.

Range of adjustment: 00000 ... 09999

Factory setting: 00001

Note: It would be as well to make a note of the code number. If you should lose this number, the PE350 will have to be sent to HBM.

Function LOCK

The status of the input lock is displayed (ON or OFF). If the input lock is active (ON), all operating steps can be carried out and reviewed, but nothing can be amended. The symbol  is displayed.

Factory setting: OFF

Function EXIT

Returns to measuring mode.

6.4 Typical settings

1. Switching the PE350 off and on, choosing battery economy mode









If the PE350 is being operated with a battery, it can be turned off or changed over to the battery economy operating mode ECO.



In ECO operating mode the displayed value is refreshed every 10 seconds.

If the PE350 is being operated with an external supply voltage, these functions can be selected just the same, but will not be carried out.

Note: If no button is pressed for about 30 seconds, the PE350 switches back to measuring mode. If it switches back before a new setting has been confirmed, this new setting does **not** take effect. You can use this security feature to cancel incorrect input that you have entered by mistake.

Switching the PE350 off and on, ECO mode:

-  Press this key. You are now in the operator dialogue, and OPERATION is displayed
-  Press this key and open the OPERATION function group
- Press   to select ON/OFF
-  Press this key. ON/OFF flashes
- Press   to select ON or OFF or ECO
- Press  to confirm

The corresponding function stops flashing and the pressure value is displayed again. Now use  or  to select another function (e.g. MAX), or select EXIT to return to measuring mode.

If you have confirmed OFF, the PE350 switches itself off after a short display test.

Switching the PE350 on again:

-  Press this key. The PE350 switches on again and goes to measuring mode

2. Setting up limit value and hysteresis

When monitoring pressures, it is often necessary to comply with certain desired values or limit values. You can set the levels for limit-value monitoring by specifying activation and deactivation thresholds. You also select the hysteresis. The hysteresis for the lower limit value works in the direction of "rising pressure"; the hysteresis for the upper limit value works in the direction of "falling pressure".

The following example illustrates the settings:





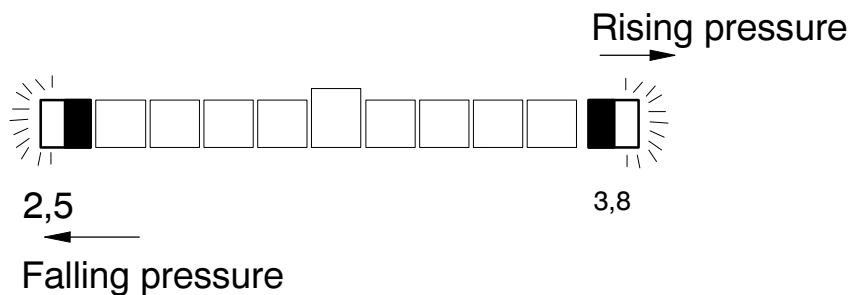

Device: 1-PE350A1/4B













Measurement task: **Undershooting** a pressure of 2.5Bar is to be displayed by a flashing lower bar graph symbol (LIM1). **Overshooting** 3.8Bar is to be displayed by a flashing upper bar graph symbol (LIM2). The hysteresis for the upper limit value is to be 3Bar.

Bar graph indicator:



Setting up LIM1, LIM2 and HYST2:

-  Press this key. You are now in the operator dialogue
- Press  to select CONFIG
-  Press this key; **LIM1** is displayed in the text box
-  Press this key; LIM1 flashes in the text box, and the measured value parameter field shows the current lower limit value
- Press  +  to set up 2.5
- Press  to confirm; the name of the function stops flashing and the measured value parameter field displays the current pressure value

- Press  to select **LIM2**
-  Press this key; LIM2 flashes in the text box, and the measured value parameter field shows the current lower limit value
- Press   to set up 3.8
- Press  to confirm
- Press  to select **HYST 2**
-  Press this key; HYST2 flashes in the text box, and the measured value parameter field shows the current hysteresis value for the upper limit value
- Press   to set up 3
- Press  to confirm
- Press   to select EXIT
- Press  to confirm; the name of the function stops flashing and the measured value parameter field displays the current pressure value.
The PE350 returns to measuring mode.

3. Setting up current output

The PE350 is set up so that the nominal measuring range corresponds to an output current of 4...20mA (these devices are also optionally available with current output 0...20mA). For setting up the range, particular pressure values are assigned to the initial current output value (4mA, or optionally 0mA) and the final current output value (20mA). The initial and final current output values can be set up independently of one another.

The range of adjustment is 1:10000 (e.g. 8.0000=4mA; 8.0001 = 20mA).

In the case of a measuring range with a spread exceeding 1:5 to 1:10, we recommend that you choose a device with the next smallest range.

Example:

Final scale value 4bar,

















1bar to be measured (spread of the measuring range 1:4).

The result of the measurement will be only negligibly affected.

0.2bar to be measured (spread of the measuring range 1:20).

In this case the measurement result, particularly due to the effects of temperature, will be too greatly affected; the selected measuring range has too large a spread.

Setting up the initial value (=4mA) and final value (=20mA) for current output

-  Press this key. You are now in the operator dialogue
- Press  to select CONFIG
-  Press this key; LIM1 is displayed in the text box
- Press   to select =0/4mA, and the measured value parameter field shows the current pressure value for 4mA
-  Press this key; =0/4mA flashes in the text box
- Press   to set up 1.700 bar
- Press  to confirm
- Press  to select =20mA (**final value for current output**)
-  Press this key; =20mA flashes in the text box, and the measured value parameter field shows the current pressure value for 20mA
- Press   to set up 3.800 bar
- Press  to confirm; the name of the function stops flashing and the measured value parameter field displays the current pressure value.
- Press   to select EXIT

The PE350 returns to measuring mode.

Effect: At a pressure of 1.7bar the PE350 delivers a current of 4mA; at a pressure of 3.8bar the current output is 20mA.

7 Overview of operating functions

Operating functions Digibar II

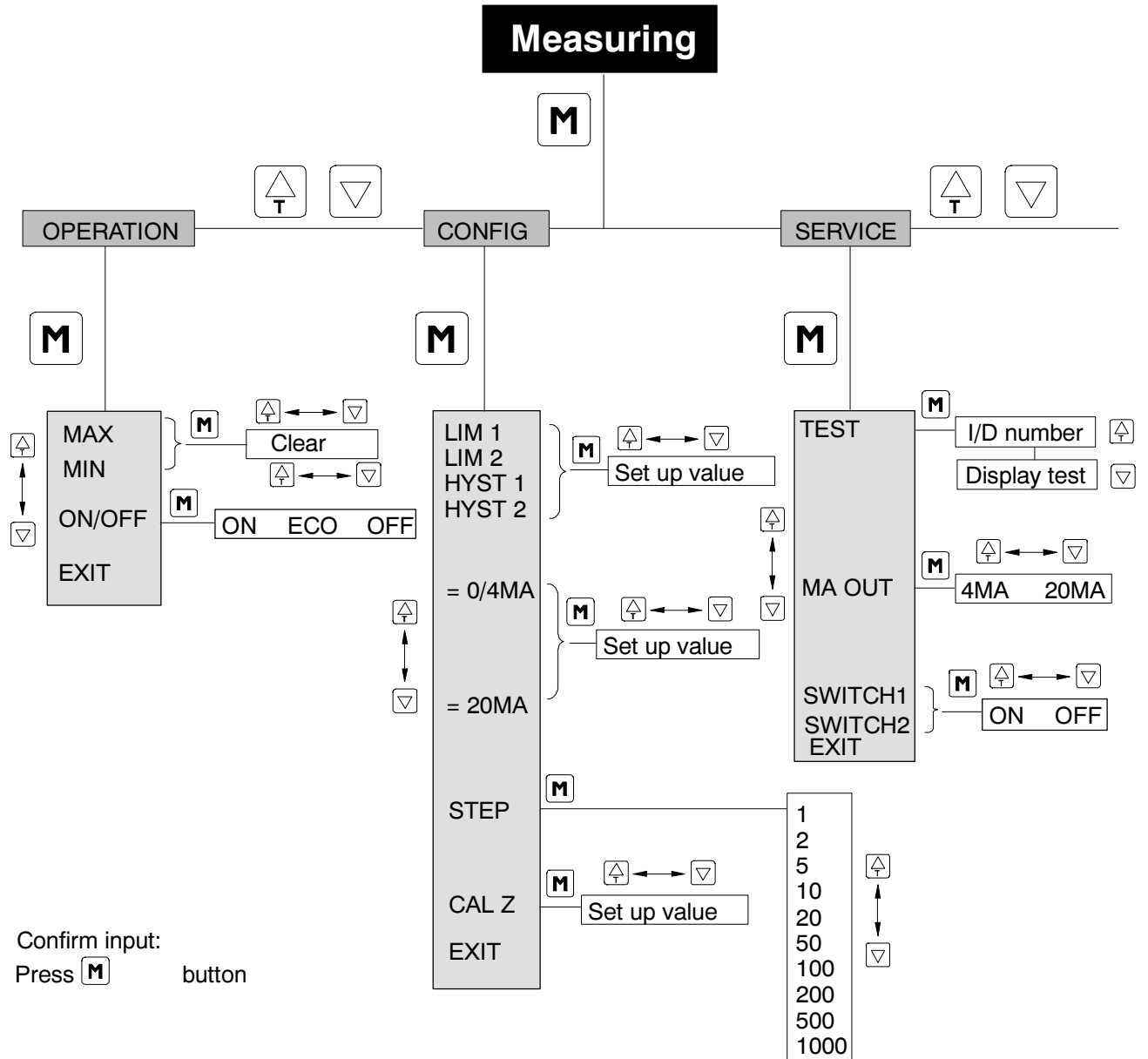

Operating functions Digibar II

Continued

Measuring

If TARE "ON" selected under SPECIAL:



M



Only for devices with Option 7 (code S)

Tare displayed value

Display gross value

SPECIAL

M

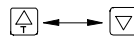

KEY

Enter number code

M

- UNIT
- %CAL S
- ZERO
- LIMLM1
- LIMLM2
- TARE
- SAVE
- RECALL
- CODE
- LOCK EXIT



Set up value

OFF ON

OFF ON

Define number code (KEY)

OFF ON

- BAR
- mBAR
- KPA
- MPA
- PSI
- mH2O
- KN
- N
- MN
- LBF
- KLBF
- KG
- G
- T
- LB
- CLB
- Nm
- KNm
- mm
- µm
- m
- IN
-

FACTOR

POINT

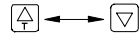

Confirm input:
Press M button

8 Technical Data

Device product family		Digibar II			
Type		1-PE350A1/...; K-PE350...			
Class of accuracy		0.2			
Class of accuracy with enhanced accuracy option for K-PE300...		-			
Mechanical input characteristics					
Nominal measuring range (gauge pressure), 0bar...	bar	0,1	0,4	4	1
Fundamental resonance frequency of membrane	kHz	10			
Attenuation ratio of membrane	1	-			
Operating range	%	-4 ... +103			-108.. +106
Overload range	%	-300..+400	-300..+1500	-30..+250	-120..+1000
Test pressure	%	200			
Limits of destructive range	%	-300 +400	-300 +1500	-30 +250	-120 +1000
With dynamic loading					
permitted pressure	%	100			
permitted oscillation bandwidth (in accordance with DIN 50 100)	%	100			
Material for parts in contact with the measurement medium		Stainless steel : 1.4301; Ceramic oxide of aluminium; fluorine caoutchouc			
Device with front-flush diaphragm seal: (flat gasket 55x48x2)		Fibres (bonded with NBR); suitable for oil, water, fuel, acid, foodstuff, etc.			
Dead volume	mm ³	1500 (Diameter of front diaphragm 25mm/ 3.2mm deep)			
Control volume	mm ³	negligible			
Output characteristics					
Display resolution of digital indicator (max.); step adjustable	d	99999			
Output span					
Indication range	mA	4...20 or 0...20			
Range (2-wire)	mA	approx. 3.6...21.6			
Range (3-wire)		approx. 0...21.6			
Relationship between current output and measured quantity (measurement span) feasible		freely adjustable 1:5			
Load, current output		see "Operating area current output"			
Factory settings					
Two-wire/three-wire relay		0bar = 4mA			
Three-wire relay		0bar =0mA			
Zero signal balancing range	%	±5			±10
Zero display point drift	%	-4...+103			-108..+106
Temperature coefficient of zero signal by reference to rated measurement span per 10K	%	<±0.2			
for "enhanced accuracy" option per 10K	%	-			

Technical Data (Continued)

Nominal measuring range (gauge pressure), 0bar...	bar	0,1	0,4	4	1
Temperature coefficient of output span by reference to actual value per 10K to actual value per 10K (for "enhanced accuracy" option)	%	<±0.2			
	%	-			
Characteristic curve deviation , starting point setting for "enhanced accuracy" option	%	<±0.2			
	%	-			
Output span tolerance for "enhanced accuracy" option	%	-			
	%	-			
Zero signal tolerance	%	<±0,5			
Hysteresis	%	0.05			
Repeat standard deviation	%	<±0.05			
Highest measurement frequency on current output	Hz	approx. 1.3			
Display rate , transmitter operation	1/s	4			
Display rate , battery operation	1/s	1			
Display rate , battery operation (ECO)	1/min	6			
Response time "MIN/MAX" value store and bar graph	Transmitter operation	s	0.5 (max.) typ. 0.25		
	Battery operation	s	1 (max.)		
	Battery operation (ECO)	s	10 (max.)		
Limit values	Range of adjustment, limit values	%	-4...+103	-108...+106	
	Range of adjustment, hysteresis	%	0..107	0...214	
Limit relay (relay board option, K-PE350...)					
Relay response time	s	0.25			
Relay release time	s	0.25			
Contact type		Changeover contact no potential and active/passive status switchable			
Maximum turn-on voltage	V _{eff}	230			
Maximum current	A	2			
supply energy					
Power supply , nominal range for transmitter operation	V	9...30V			
Max. current consumption (initial current flow)	mA	30 (without relay)			
Max. current consumption for operation with relay board	mA	125			
Rated voltage , battery operation	V	3.6			
Supply voltage range , battery operation	V	2,7...3,8			
Recommended battery type		Lithium battery 3.6V, 13.5Ah Size D 2x miniatures 1.5V; Size AA			
Alternative battery operation					
Battery life (continuous operation)		>9 months			
Battery life (continuous operation, ECO)		>18months			
Battery service life , with 2 x 1.5V miniature cells (alkaline), continuous		>3 weeks			

Technical Data (Continued)

Ambient conditions		
Rated temperature range	°C	-20...+70
Function LCD	°C	-10...+60
Operating temperature range	°C	-25...+70
Storage temperature range	°C	-40...+70
Max. mean temperature with cooling by ambient temperature (<60°C)	°C	125
Reference temperature	°C	23
Impact resistance (type approval in accordance with DIN IEC68)		
Impact acceleration	m/s ²	<650
Vibration acceleration (frequency 10Hz...100Hz)	m/s ²	<150
Vibration acceleration, function of relay	m/s ²	<40
EMC		
Immunity from interference		EN50082-2
Spurious emission		EN50011, EN50022 Class B
Measurement drift	%	≤0.5
Protection system in accordance with DIN 40 050, IEC 529		
		IP65
Material for parts in contact with the environment		
		Aluminium polyester coated; polyamide 6.6; stainless steel 1.4301; steel, galvanised; brass, nickel-plated; perbunan; silicone rubber
Installation position		
		as required
Weight		
	g	900

Accessories (in list of components supplied):

Skintop PG16 cable gland, battery contact springs, gaskets

Accessories (to order):

Lithium battery 3.6V 13.5Ah	Order No. 3-3319.0009
Plug-in power pack	Order No. 3-3318.0002
Power pack for support rail mounting	
230V, 50...60Hz / 15V=650mA	Order No. 1-NT101A
Bracket for support rail mounting	Order No. 2-9289.1713

9 Dimensions

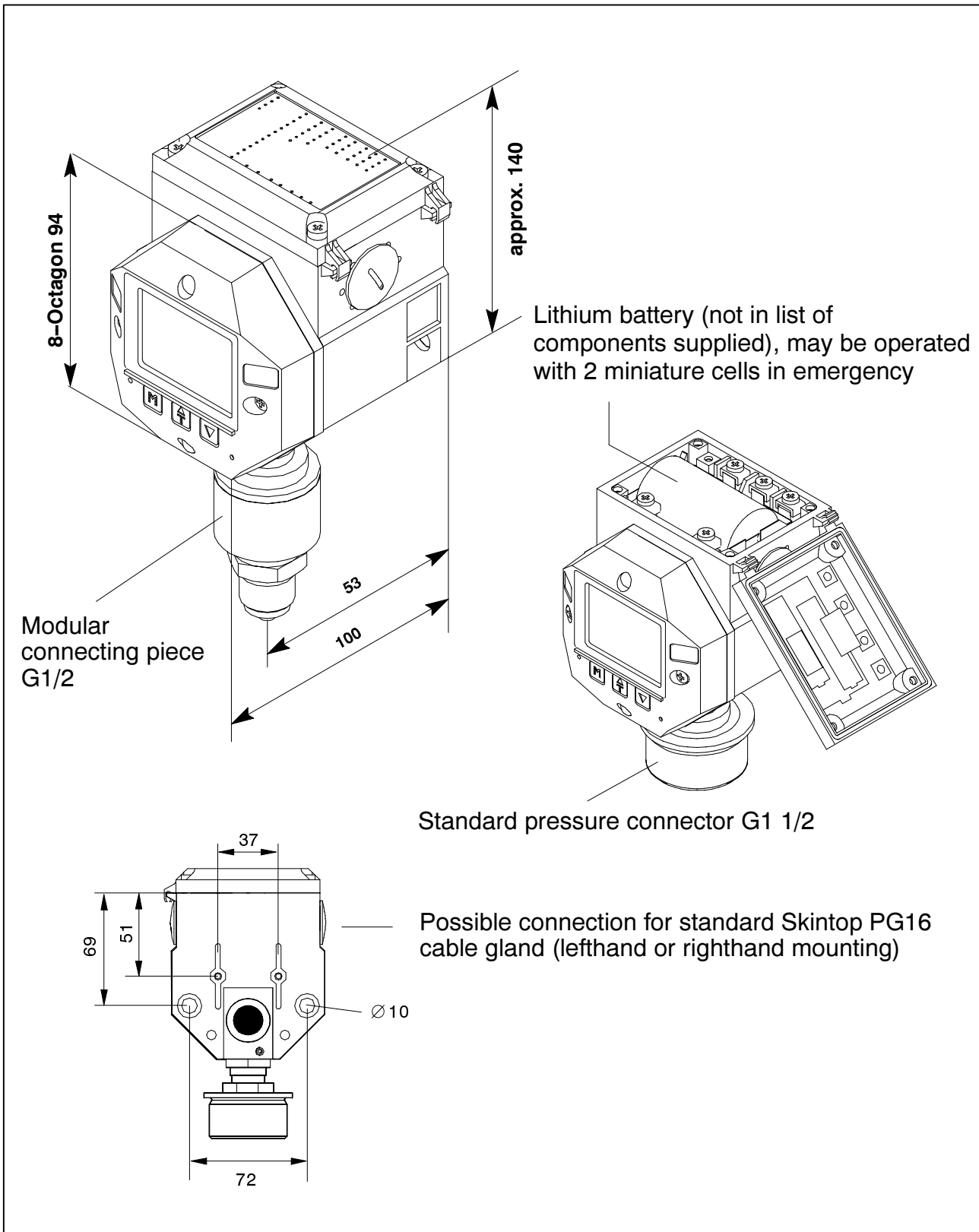

10 Adjustment ranges and factory settings for PE350

Percentage data in relation to numerical values in the unit of pressure.

OPERATION

- MAX:** Clear peak value and adopt current measured value; no factory setting
- MIN:** Clear minimum value and adopt current measured value; no factory setting
- ON/OFF:** ON, ECO, OFF (after OFF: reactivate with M); factory setting: ON
Under certain conditions of rising excitation voltage, a "wake-up call" with M necessary.

CONFIG

- LIM 1:** generally: -4% ... +103%
in practice: -4% ... LIM2
For devices with the SPECIAL control panel: LMLIM1 ... LIM2
Factory setting: initial value (0)
- LIM 2:** generally: -4% ... +103%
in practice: LIM 1 ... +103%
For devices with the SPECIAL control panel: LIM1 ... LMLIM 2
Factory setting: final value (100%)
- HYST 1:** Direction fully defined, HYST 1 "link" extends from LIM 1 towards LIM 2; 0 ... 107%
Factory setting: 5%
- HYST 2:** Direction fully defined, HYST 2 "link" extends from LIM 2 towards LIM 1; 0 ... 107%
Factory setting: 5%
- 0/4 MA:** Initial value of current output 4mA or 0mA according to order.
Adjustment range: whole numerical range
Factory setting: final value = 100%

20mA: Adjustment range: whole numerical range
Factory setting: final value = 100%

STEP: 1, 2, 5, 10, 20, 50, 100, 200, 500, 1000
factory setting: =0.1% of final value

CAL Z: -5 ... +5%
Factory setting: 0

SERVICE

TEST: - Error code, if error present
- Up button: date of manufacture
- Down button: display test; all segments are displayed

MA OUT: Depending on the initial value of the current output (i.e. depending on the device option ordered), then regardless of the current measured value the downstream measuring system will be fed with a current of 0 or 4mA, or 20mA.

SWITCH: ON or OFF.
When ON, the limit value relays operate regardless of the current measured value.

If the device includes the "SPECIAL" control panel:

KEY: Depending on the setting in CODE
Factory setting: 00001

UNIT: BAR, mBAR, KPA, MPA, PSI, mH₂O
Pressure units **with** automatic conversion. Other units without automatic conversion:
KN, N, MN, LBF, KLBF, KG, G, T, LB, KLB, NM, KNM, mm, μm, m, IN

If another physical quantity needs to be displayed when pressure is being measured:

FACTOR: Suitable setting range, as appropriate to the nominal measuring range, so that the decimal point is not moved.
Initial value: 1.000

POINT: Moves the decimal point in the measured value. The measured value has been converted with FACTOR.
Initial value as specified for BAR

% CAL S: -5 ... +5 (**in this case unit %**)
Factory setting: 0

ZERO: -4 ... +103% (**not in %**, but unit as selected)
Factory setting: 0

LMLIM 1: -4% ... +103%
Factory setting: -4%

LMLIM 2: -4 ... +103%
Factory setting: 103%

TARE: ON or OFF
Factory setting: OFF

SAVE: ON or OFF
Factory settings: OFF
ON saves a record of the set-up data for this list.
Caution:
After a SAVE with changed settings, the factory settings stored under RECALL are overwritten.

- RECALL: ON or OFF
 Factory settings: OFF
 ON: In the delivered state, the current device settings record
 will be replaced by the factory settings record as in this list.
- CODE: Default for KEY.
 00000 ... 09999
 Caution:
 Always make a note of the value that is set up. You will need
 to input this value under KEY.
 Factory setting: 00001
- LOCK: ON or OFF
 Factory setting: OFF

12 Certificate of Conformance



**HOTTINGER
BALDWIN
MESSTECHNIK**

HOTTINGER BALDWIN MESSTECHNIK GMBH
Im Tiefen See 45 - D-64293 Darmstadt
Tel. ++49/6151/803-0, Fax. ++49/6151/894896

Konformitätserklärung

Declaration of Conformity

Déclaration de Conformité

Document: 085/01.1997

Wir,

We,

Nous,

Hottinger Baldwin Messtechnik GmbH, Darmstadt

erklären in alleiniger Verantwortung, daß das Produkt

declare under our sole responsibility that the product

déclarons sous notre seule responsabilité que le produit

Digitales Überdruckmeßgerät DIGIBAR II der Typenreihen PE 300 (ab 2/96), PDE 300 , PE 350

auf das sich diese Erklärung bezieht, mit der/den folgenden Norm(en) oder normativen Dokument(en) übereinstimmt (siehe Seite 2) gemäß den Bestimmungen der Richtlinie(n)

to which this declaration relates is in conformity with the following standard(s) or other normative document(s) (see page 2) following the provisions of Directive(s)

auquel se réfère cette déclaration est conforme à la (aux) norme(s) ou autre(s) document(s) normatif(s) (voir page 2) conformément aux dispositions de(s) Directive(s)

89/336/EWG - Richtlinie des Rates vom 3. Mai 1989 zur Angleichung der Rechtsvorschriften der Mitgliedsstaaten über die elektromagnetische Verträglichkeit, geändert durch 91/263/EWG, 92/31/EWG und 93/68/EWG

Die Absicherung aller produkt-spezifischen Qualitätsmerkmale erfolgt auf Basis eines von der DQS (Deutsche Gesellschaft zur Zertifizierung von Qualitätsmanagementsystemen) seit 1986 zertifizierten Qualitätsmanagementsystems nach DIN ISO 9001 (Reg.Nr. DQS-10001).

Die Überprüfung der sicherheitsrelevanten Merkmale (Elektromagnetische Verträglichkeit, Sicherheit elektrischer Betriebsmittel) führt ein von der DATech erstmals 1991 akkreditiertes Prüflaboratorium (Reg.Nr. DAT-P-006 und DAT-P-012) unabhängig im Hause HBM durch.

All product-related features are secured by a quality system in accordance with DIN ISO 9001, certified by DQS (Deutsche Gesellschaft zur Zertifizierung von Qualitätsmanagementsystemen) since 1986 (Reg. No. DQS-10001). The safety-relevant features (electromagnetic compatibility, safety of electrical apparatus) are verified at HBM by an independent testing laboratory which has been accredited by DATech in 1991 for the first time (Reg. Nos. DAT-P-006 and DAT-P-012).

Chez HBM, la détermination de tous les critères de qualité relatifs à un produit spécifique est faite sur la base d'un protocole DQS (Deutsche Gesellschaft zur Zertifizierung von Qualitätsmanagementsystemen) certifiant, depuis 1986, notre système d'assurance qualité selon DIN ISO 9001 (Reg.Nr. DQS-10001).

De même, tous les critères de protection électrique et de compatibilité électromagnétique sont certifiés par un laboratoire d'essais indépendant et accrédité depuis 1991 (Reg.Nr. DAT-P-006 et DAT-P-012).

Darmstadt, 31.01.1997

Seite 2 zu

Page 2 of

Page 2 du

Document:

085/01.1997

Diese Erklärung bescheinigt die Übereinstimmung mit den genannten Richtlinien, beinhaltet jedoch keine Zusicherung von Eigenschaften.
Die Sicherheitshinweise der mitgelieferten Produktdokumentation sind zu beachten.

This declaration certifies conformity with the Directives listed above, but is no asseveration of characteristics.
Safety directions of the delivered product documentation have to be followed.

Cette déclaration atteste la conformité avec les directives citées mais n'assure pas un certain caractère.
S.v.p. observez les indications de sécurité de la documentation du produit ajoutée.

Folgende Normen werden zum Nachweis der Übereinstimmung mit den Vorschriften der Richtlinie(n) eingehalten:

The following standards are fulfilled as proof of conformity with the provisions of the Directive(s):

Pour la démonstration de la conformité aux disposition de(s) Directive(s) le produit satisfait les normes:

EN 50082-2 : 1995

Elektromagnetische Verträglichkeit (EMV); Fachgrundnorm Störfestigkeit; Teil 2: Industriebereich; Deutsche Fassung

EN 55011 : 1991

Funk-Entstörung von Elektrischen Betriebsmitteln und Anlagen; Grenzwerte und Meßverfahren für Funkstörungen von industriellen, wissenschaftlichen und medizinischen Hochfrequenzgeräten (ISM-Geräten) (CISPR 11 : 1990, modifiziert); Deutsche Fassung

... und:

EN 55022 : 1994

Elektromagnetische Verträglichkeit von Einrichtungen der Informationsverarbeitungs- und Telekommunikationstechnik; Grenzwerte und Meßverfahren für Funkstörungen von informationstechnischen Einrichtungen (IEC CISPR 22: 1993; Deutsche Fassung

B		F	
Bar graph	20, 21, 27	FACTOR	31
Battery contact spring	13, 16	Front of housing	10
Battery contact springs	13	Function	23, 24
Battery economy mode	35	Function group	23, 24
Battery service life	15	Functions group	30
Battery symbol	22		
Button functions	23	G	
		GROSS	33
C		H	
CAL Z	29	HYST	37
CODE	34	HYST	1, 27
Code	50	Hysteresis	22, 27, 36
CONFIG	26		
Connections	12	I	
Current input	37	Input lock	22
Current output	28, 32, 37		
final value	22	K	
initial value, final value	38	KEY	30
starting value	22		
D		L	
Decimal point	32	LIM	1, 26
Digital manometer	12	LIM	2, 27
Dimensions	44	LIM	1, 36
Display position	10	Limit value	21, 22, 26, 27, 36
		Lithium battery	8, 12, 14, 15
E		inserting	13
ECO	15, 35	LMLIM1	33
EXIT	26	LOCK	34

M

MAX	25
Measuring mode	24
Measuring rate	26
Menu block	20, 21, 23, 24
MIN	26
MIN /MAX	22
Miniature cells	15
Multi-function display	20

N

NET	33
Numerical step-width	29

O

ON/OFF	26
Operating	24
Operating functions	25, 39
Operating mode	12
OPERATION	25
Operator dialogue	22, 23
Option	30
Options	45, 49
Order code	30, 50
Output current	29, 37

P

Pipe mounting	12
POINT	32
Power supply	12, 16
Pressure measurement transmitter	12

R

RECALL	33
Relay board	17, 27

S

SAVE	33
Scrolling	23
SERVICE	29
SPECIAL	30
STEP	29
Support rail mounting in C form	8, 11 11
SWIT1/SWIT2	30
Symbol bar, 20, 22	

T

TARE, 33	
Tare buffer, 23	
Tend indicator, 20	
TEST, 29	
Text box, 20, 21	

U

UNIT, 30	
----------	--

Z

ZERO, 32	
----------	--



HOTTINGER BALDWIN MESSTECHNIK
HBM Mess- und Systemtechnik GmbH

Postfach 10 01 51, D-64201 Darmstadt
Im Tiefen See 45, D-64293 Darmstadt
Tel.: +49/ 61 51/ 8 03-0; Fax: 89 48 96;

www.hbm.de

Modifications reserved.

All details describe our products in general form only. They are not to be understood as express warranty and do not constitute any liability whatsoever.